

**特点 Features:**

- 高触点容量: 80A触点切换能力  
High contact switching capability: 80A.
- 工作温度高达125°C  
Extended temp. ranges up to 125°C.
- 可并联电阻或二极管  
Resistor or diode paralleled type available.

**触点参数 CONTACT DATA**

型号	Model	YQ507
触点形式	Contact Arrangement	1A, 1C
接触电阻	Contact Resistance	50mΩ Max.
触点材料	Contact Material	银合金 Silver Alloy
额定负载(阻性)	Contact Rating ( Res.Load )	80A 14VDC
最大切换电流	Max. Switching Current	80A
最大切换电压	Max. Switching Voltage	50VDC
最大切换功率	Max. Switching Power	1120W
机械寿命	Mechanical endurance	1x10 <sup>7</sup> 次 OPS
电气寿命	Electrical endurance	1x10 <sup>5</sup> 次 OPS

**性能参数 CHARACTERISTICS**

吸合时间(额定电压下)	Operate Time ( at nomi.volt. )	10ms Max.
释放时间(不带二极管)	Release Time ( without diode )	7ms Max.
绝缘电阻	Insulation Resistance	100MΩ Min.( 500VDC )
介质耐压	Dielectric Strength	触点与触点间 Between Open Contacts : 500VAC, 50/60Hz 1 min.
		触点与线圈间 Between Coil & Contacts: 500VAC, 50/60Hz 1 min.
抗振性	Vibration resistance	误动作 Functional: 10~55Hz 双振幅 1.5mm ( DA )
		耐久 Destructive: 10~55Hz 双振幅 1.5mm ( DA )
抗冲击	Shock resistance	误动作 Functional: 10G Min.
		耐久 Destructive: 100G Min.
环境温度	Ambient Temperature	-40°C~+125°C (不冷凝 No condensation)
重量	Unit Weight	普通型 conventional type : 约 Approx. 38g , PCB : 约 Approx. 37g

**线圈参数 COIL DATA (at 23°C)**

额定电压 Rated voltage (VDC)	额定电流 Rated current ±10%(mA)	线圈电阻 Coil resistance ±10%(Ω)	并联电阻 Parallel resistance (Ω)	等效电阻 Equivalent resistance (Ω)	最大连续外加电压 Max allowable voltage VDC (Max.)	吸合电压 Operate voltage VDC (Max.)	释放电压 Release voltage VDC (Min.)	额定功率 Rated coil power (W)
12	133.5	90			额定电压的 of rated voltage 150 %	额定电压的 of rated voltage 70 %	额定电压的 of rated voltage 10 %	约 approx. 1.6/1.8
24	67.0	360						
12	150.9	90	680	79.5				
24	75.6	360	2,700	317.5				
12	167.0	72			额定电压的 of rated voltage 150 %	额定电压的 of rated voltage 70 %	额定电压的 of rated voltage 10 %	约 approx. 2.0/2.2
24	83.5	288						
12	184.6	72	680	65				
24	92.3	288	2,700	260				

## 订货标记示例 ORDERING INFORMATION

YQ507	-S	-1	12	D	M	F	R	
附加电路		Accessory Form :		无-标准型, D-带二极管, R-带电阻 Nil-Without accessory, D-With diode, R-With resistor				
结构形式		Version :		无-无靠背+QC引出端, F-塑靠背+QC引出端, F1-铁靠背+QC引出端子, P-无靠背+PCB引出端 Ni- Without Bracket & QC Terminal, F- Plastic Bracket & QC Terminal, F1-Iron Bracket & QC Terminal, P-Without Bracket & PCB Terminal				
触点形式		Contact form :		无-转换, M-常开 Nil-Form C, M-Form A				
线圈功耗		Coil power :		D-1.6W/1.8W; H-2.0W/2.2W				
线圈规格		Coil voltage :		12,24(VDC)				
触点组数		Number of poles :		1-1组 1-1 Group				
封装形式		Protective construction :		S-塑封式 S-Flux proofed				
基本型号		Type designation :		YQ507				

## 外形尺寸、接线图、安装孔位图 (单位: mm)

## OUTLINE DIMENSIONS, WIRING DIAGRAM AND PCB LAYOUT (Unit: mm)

外形尺寸

Outline Dimensions

标准型  
standard type

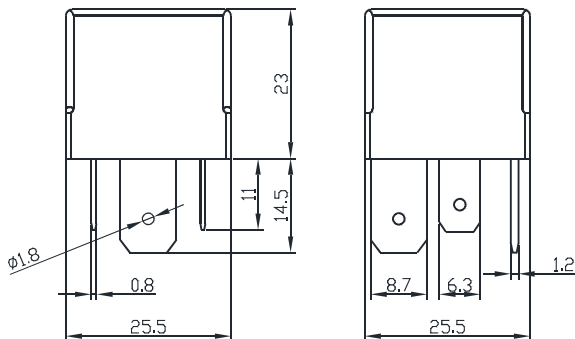

安装孔位图 (底视图)

PCB Layout ( Bottom View )

转换型  
1 Form C

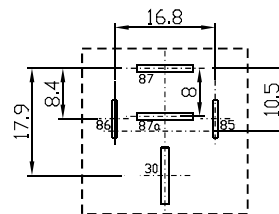

常开型  
1 Form A

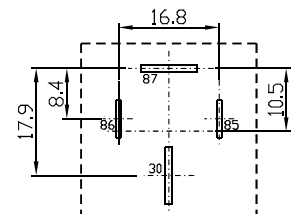

PCB型  
PCB type

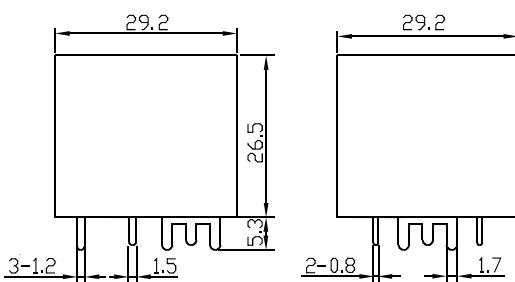

转换型  
1 Form C

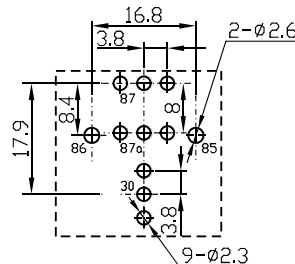

常开型  
1 Form A

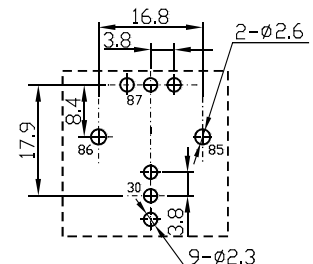

## 外形尺寸、接线图、安装孔位图 (单位: mm) OUTLINE DIMENSIONS, WIRING DIAGRAM AND PCB LAYOUT (Unit: mm)

外形尺寸  
Outline Dimensions

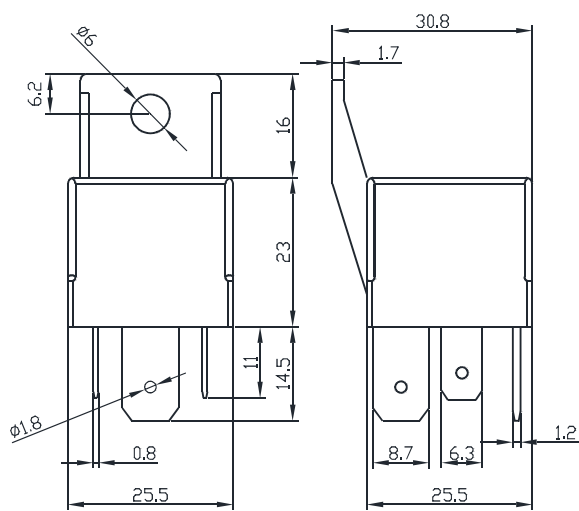

塑背型  
Plastic Bracket

接线图 (底视图)  
Wiring Diagram (Bottom View)

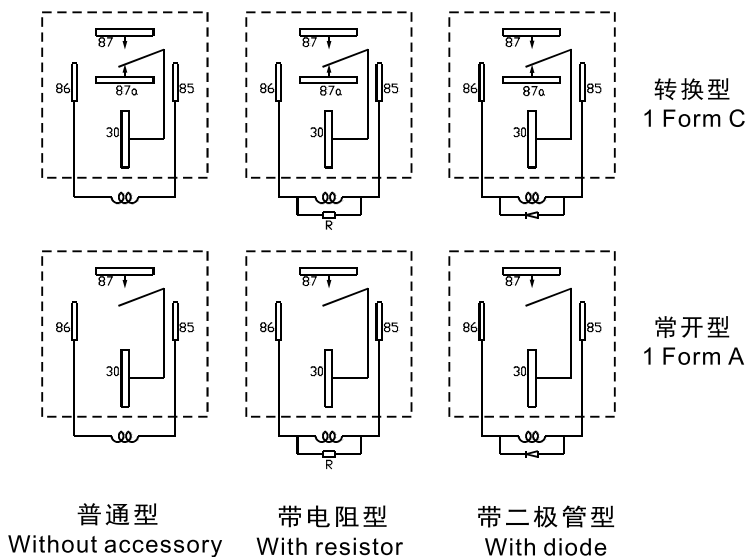

转换型  
1 Form C

常开型  
1 Form A

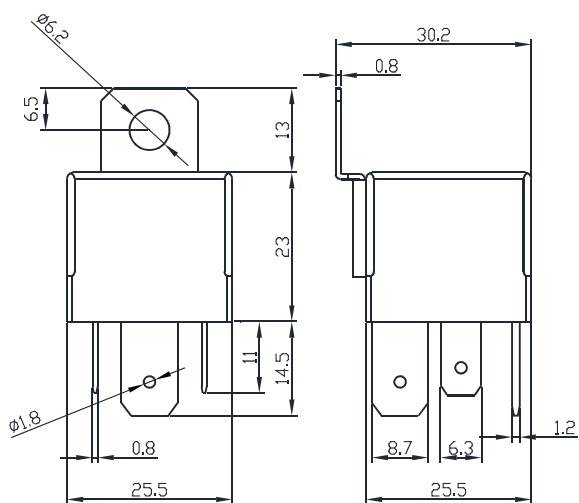

铁背型  
Iron Bracket

注 Remark :

- 1.未标注尺寸公差 Unmarked dimensional tolerance  
≤1mm: ±0.2mm ; (1~5)mm: ±0.3mm ; ≥5mm: ±0.4mm.
- 2.安装孔尺寸公差: ±0.1mm.  
The tolerance of PCB layout is always: ±0.1mm.
- 3.引出脚尺寸为预焊前尺寸.  
Extended terminal dimension is dimension before soldering.